



# omniPAGE Mini

The perfect unit for routine vertical electrophoresis using pre-cast or hand-cast gels. The omniPAGE MINI features injection moulded construction for leak proof running, and a simple clamp system to ensure a tight seal between buffer chambers to prevent current leakage.

Gel casting and running is done using the same internal module, no transfer of glass plates during gel casting is necessary. The module features unique sliding gates, to allow very rapid set up of both hand cast and precast gels. Ultra soft silicone seals and pressure bars which surround the glass plates guarantee leak proof gel casting. 2mm thick glass plates minimise breakage and have bonded spacers for convenience.

## MINI TETRAD

A 4-gel TETRAD system is created by simply introducing additional plates with spacers and appropriate combs. TETRAD is supplied with a casting base and external casting upstand to allow gels to be prepared in advance, ready for the next run.

## interchangeable modules

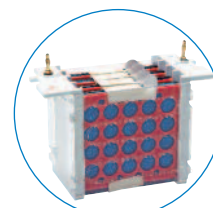

**Electroblotting Module** – Complete with Platinum wire electrodes, 4 blotting cassettes and fibre pads to aid compression, this insert fits neatly into the omniPAGE Mini tank for Western Blotting.

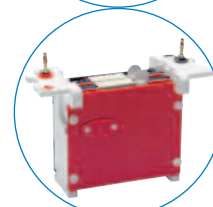

**High Intensity Electroblotting Module** – with 2 blotting cassettes and Platinum plate electrodes, the high intensity blotting module allows fast transfer of proteins to membranes with excellent time savings.

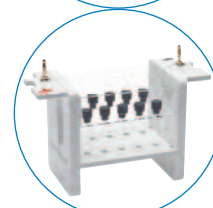

**Capillary IEF Module** - the Tube Gel Module includes a rapid release gasket for easy tube extraction. Focusing can be accomplished in as little as three hours.

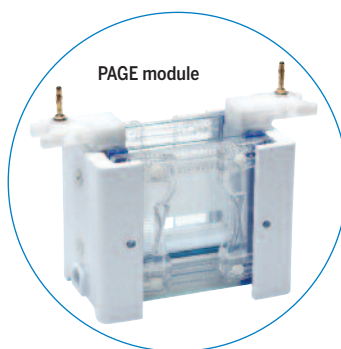
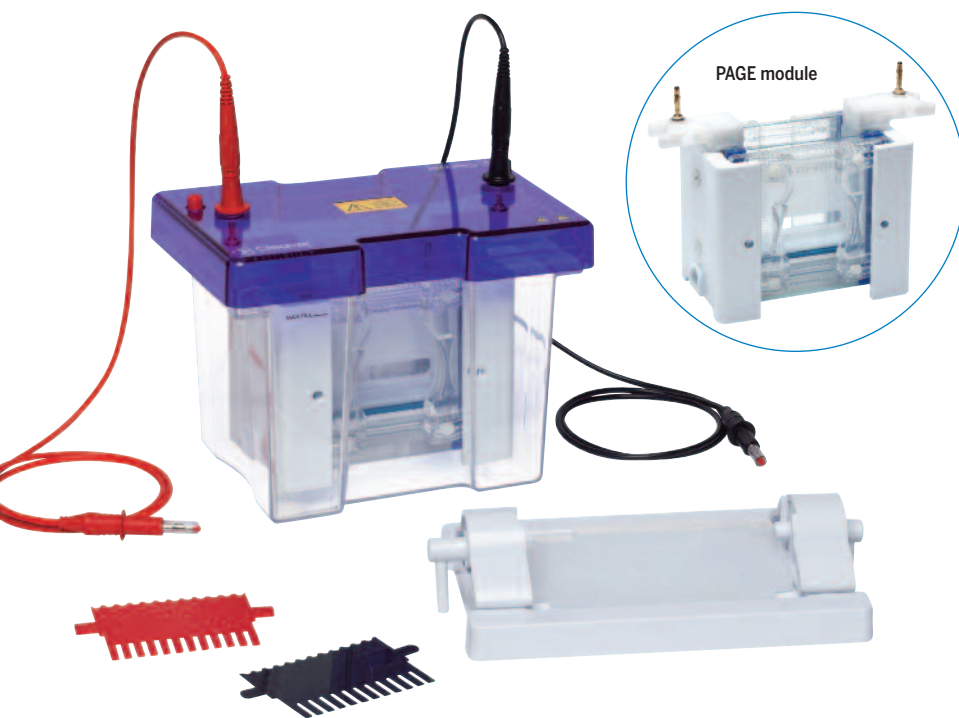

## KEY FEATURES

### Mini SDS PAGE, Native PAGE, Gradient, Second dimension and Nucleic acid separations

- Injection moulded construction
- Compatible with all 8 x 10 and 10 x 10cm precast gels
- Rapid gel casting and loading
- Low buffer volumes
- Rapid set up cooling
- Run up to four gels in tetrad model



For vertical package deals

## ORDERING INFORMATION

<b>CVS10D</b>	<b>omniPAGE Mini</b> , 10 x 10cm includes Glass Plates with bonded 1mm thick spacers, 2x 12 sample combs, cooling pack, blanking plate		
<b>CVS10DSYS</b>	<b>omniPAGE Mini</b> , 10 x 10cm includes Glass Plates with bonded 1mm thick spacers, 2x 12 sample combs, cooling pack, blanking plate and casting base		
<b>CVS10DSYS-CU</b>	<b>omniPAGE Mini</b> , 10 x 10cm incl. Glass Plates with bonded 1mm thick spacers, 2x 12 sample combs, cooling pack, blanking plate, casting base and casting upstand		
<b>CVS10TETRAD</b>	<b>omniPAGE Mini</b> , 10 x 10cm incl. Glass Plates with bonded 1mm thick spacers, 2x 12 sample combs, cooling pack, blanking plate, casting base and casting upstand PLUS 2x additional 1mm 12-sample combs, 1x pk/2 plain glass plates with 1mm spacers, 1x pk/2 notched glass plates and 2x pk/2 notched glass plates with 1mm spacers		
CVS10PRE	omniPAGE Mini, 10 x 10cm includes blanking plate, cooling pack		
VS10DCAST	10 x 10cm Casting Base	VS10NGS1.5	10 x 10cm Notched Glass Plates with 1.5mm Bonded Spacers (pk/2)
VS10DCASTM	Replacement Silicone Mat for 10 x 10cm Casting Base	VS10PGS1.5	10 x 10cm Plain Glass Plates with 1.5mm Bonded Spacers (pk/2)
CVS10DIRM	Inner Running Module, with Sliding Clamps or Screw Clamps	VS10NGS2	10 x 10cm Notched Glass Plates with 2mm Bonded Spacers (pk/2)
VS10ICB	Mini Cooling Pack	VS10PGS2	10 x 10cm Plain Glass Plates with 2mm Bonded Spacers (pk/2)
VS10NG	10 x 10cm Notched Glass Plates 2mm thick (pk/2)	VS10DP	Blanking Plate, 10 x 10cm
VS10PG	10 x 10cm Plain Glass Plates 2mm thick (pk/2)	VS10S0.75	10cm Spacers - 0.75mm (pk/2)
VS10NGS0.75	10 x 10cm Notched Glass Plates with 0.75mm Bonded Spacers (pk/2)	VS10S1	10cm Spacers - 1mm thick (pk/2)
VS10PGS0.75	10 x 10cm Plain Glass Plates with 0.75mm Bonded Spacers (pk/2)	VS10S1.5	10cm Spacers - 1.5mm thick (pk/2)
VS10NGS1	10 x 10cm Notched Glass Plates with 1mm Bonded Spacers (pk/2)	VS10S2	10cm Spacers - 2mm thick (pk/2)
VS10PGS1	10 x 10cm Plain Glass Plates with 1mm Bonded Spacers (pk/2)		

## simple, rapid, leak-proof gel casting....

Dual purpose PAGE module eliminates time-consuming transfer of glass plates between separate casting and running

Ground glass plates with bonded injection moulded spacers consistent with comb thickness ensure 'clean' well formation, as well as the correct alignment for leak-free casting; also eliminate the need for easily mislaid and awkward to use spacer aligners

Very forgiving, ultra-soft silicone mat within cam-caster compensates for glass plate misalignment to ensure leak-free casting



Insert glass plates between pressure frame and gasket

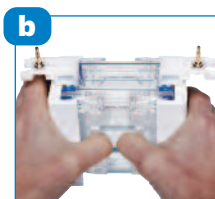

Slide gates to make efficient seal

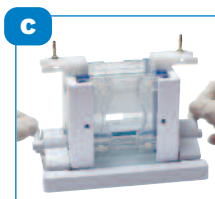

Transfer to casting base and tighten cams

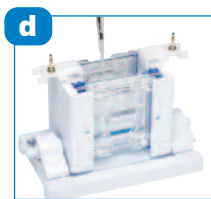

Insert gel solution and comb and allow to polymerise



Transfer to tank and fill with buffer

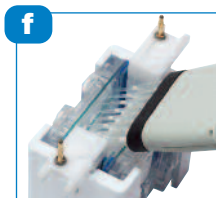

Load samples using Loading Guides and run

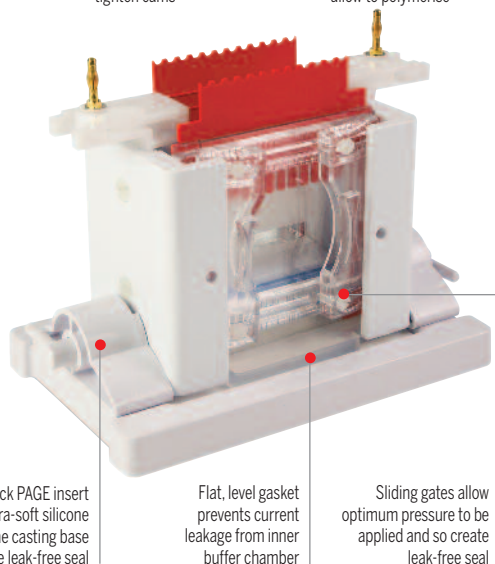

Cam pins lock PAGE insert onto the ultra-soft silicone mat within the casting base to provide leak-free seal

Flat, level gasket prevents current leakage from inner buffer chamber

Sliding gates allow optimum pressure to be applied and so create leak-free seal

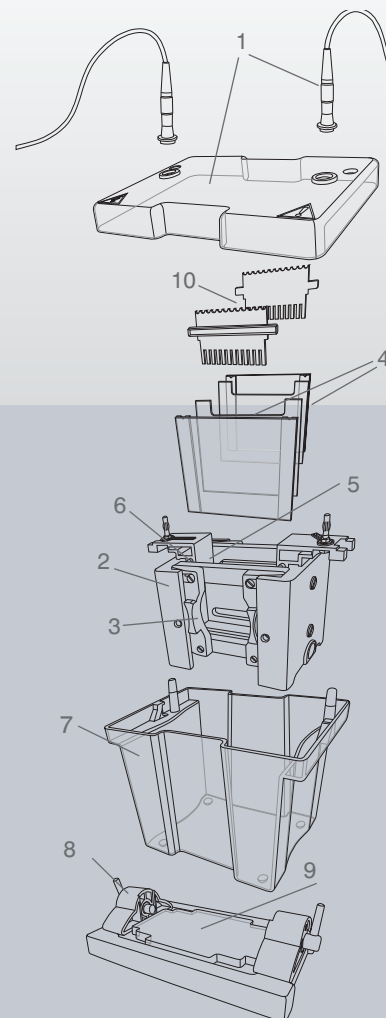

### Mini component parts

- |                         |                           |
|-------------------------|---------------------------|
| 1. Lid and power cables | 6. Gasket                 |
| 2. PAGE insert          | 7. Outer tank             |
| 3. Sliding clamps       | 8. Cam-pin caster         |
| 4. Glass plates         | 9. Ultra-soft casting mat |
| 5. Inner buffer chamber | 10. Combs                 |

Colour	CODE	DESCRIPTION	SAMPLE VOLUME PER WELL
Black	VS10-1-0.75	Comb 1 Prep, 1 Marker, 0.75mm thick	500µl
	VS10-5-0.75	Comb 5 sample, 0.75mm thick	70µl
	VS10-8MC-0.75	Comb 8 sample MC, 0.75mm thick	40µl
	VS10-9-0.75	Comb 9 sample, 0.75mm thick	35µl
	VS10-10-0.75	Comb 10 sample, 0.75mm thick	30µl
	VS10-12-0.75	Comb 12 sample, 0.75mm thick	25µl
	VS10-16MC-0.75	Comb 16 sample MC, 0.75mm thick	20µl
	VS10-20-0.75	Comb 20 sample, 0.75mm thick	15µl
White	VS10-1-1	Comb 1 Prep, 1 Marker, 1mm thick	650µl
	VS10-5-1	Comb 5 sample, 1mm thick	100µl
	VS10-8MC-1	Comb 8 sample MC, 1mm thick	60µl
	VS10-9-1	Comb 9 sample, 1mm thick	50µl
	VS10-10-1	Comb 10 sample, 1mm thick	40µl
	VS10-12-1	Comb 12 sample, 1mm thick	35µl
	VS10-16MC-1	Comb 16 sample MC, 1mm thick	25µl
	VS10-20-1	Comb 20 sample, 1mm thick	20µl

Colour	CODE	DESCRIPTION	SAMPLE VOLUME PER WELL
Red	VS10-1-1.5	Comb 1 Prep, 1 Marker, 1.5mm thick	1000µl
	VS10-5-1.5	Comb 5 sample, 1.5mm thick	140µl
	VS10-8MC-1.5	Comb 8 sample MC, 1.5mm thick	80µl
	VS10-9-1.5	Comb 9 sample, 1.5mm thick	70µl
	VS10-10-1.5	Comb 10 sample, 1.5mm thick	30µl
	VS10-12-1.5	Comb 12 sample, 1.5mm thick	50µl
	VS10-16MC-1.5	Comb 16 sample MC, 1.5mm thick	40µl
	VS10-20-1.5	Comb 20 sample, 1.5mm thick	30µl
Blue	VS10-1-2	Comb 1 Prep, 1 Marker, 2mm thick	1300µl
	VS10-5-2	Comb 5 sample, 2mm thick	200µl
	VS10-8MC-2	Comb 8 sample MC, 2mm thick	120µl
	VS10-9-2	Comb 9 sample, 2mm thick	100µl
	VS10-10-2	Comb 10 sample, 2mm thick	80µl
	VS10-12-2	Comb 12 sample, 2mm thick	70µl
	VS10-16MC-2	Comb 16 sample MC, 2mm thick	50µl
	VS10-20-2	Comb 20 sample, 2mm thick	40µl

MC = multichannel pipette compatible



# omniPAGE Mini Modular Systems

The omniPAGE range of Modular Vertical Gel Systems allow multiple electrophoresis techniques to be performed in the same unit. Using the same main tank and lid, three different modules are interchangeable for PAGE, tube gel and electroblotting techniques.

Each Modular System comprises the Gel Chamber, PAGE Internal Running Module, Casting Base and various accessories. Through the addition of further modules, the packages flexibility is increased to allow Western blotting and Capillary IEF.

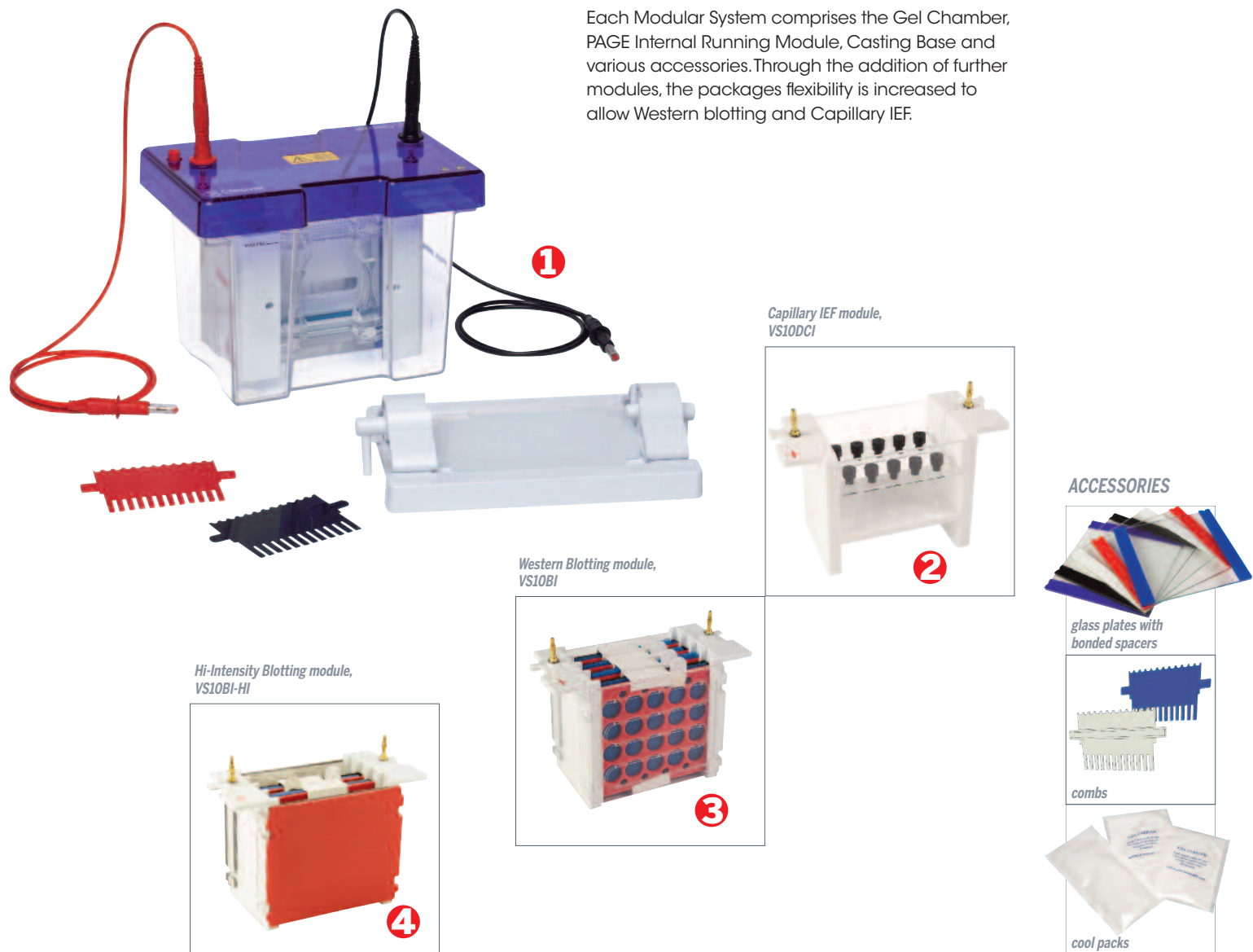

## ORDERING INFORMATION

<b>CVS10CES</b>	<b>Complete Mini (10x10cm) Vertical Electrophoresis Modular System</b> , comprising: 1x Mini Vertical Unit, CVS10DSYS (1) which includes: PAGE Module, 2x2mm thick notched glass plates, 2x2mm thick plain glass plates with 1mm thick bonded spacers, 1x blanking plate, 2x combs (1mm thick, 12 samples), 1x casting base, silicone mat, cooling pack plus: 1x Capillary Electrophoresis Module, VS10DCI (2) and 1x Electroblotting Module, VS10BI (3) comprising: internal electroblotting module, 4x compression cassettes for gel sizes up to 10x10cm and 8x fibre pads		
<b>CVS10C2DS</b>	<b>Complete Mini (10 x 10cm) Vertical Electrophoresis &amp; 2-D System</b> , comprising: 1x Mini Vertical Unit, CVS10DSYS (1) which includes: PAGE Module, 2x2mm thick notched glass plates, 2x2mm thick plain glass plates with 1mm thick bonded spacers, 1x blanking plate, 2x combs (1mm thick, 12 samples), 1x casting base, silicone mat, cooling pack plus: 1x Capillary Electrophoresis Module, VS10DCI (2)		
<b>CVS10CBS</b>	<b>Complete Mini (10 x 10cm) Vertical Electrophoresis &amp; Blotting System</b> , comprising: 1x Mini Vertical Unit, CVS10DSYS (1) which includes: PAGE Module, 2x2mm thick notched glass plates, 2x2mm thick plain glass plates with 1mm thick bonded spacers, 1x blanking plate, 2x combs (1mm thick, 12 samples), 1x casting base, silicone mat, cooling pack plus 1x Standard Electroblotting Module, VS10BI (3)		
<b>CVS10CBS-HI</b>	<b>Complete Mini (10 x 10cm) Vertical Electrophoresis &amp; High Intensity Blotting System</b> , comprising: 1x Mini Vertical Unit, CVS10DSYS (1) which includes: PAGE Module, 2x2mm thick notched glass plates, 2x2mm thick plain glass plates with 1mm thick bonded spacers, 1x blanking plate, 2x combs (1mm thick, 12 samples), 1x casting base, silicone mat, cooling pack plus: 1x High Intensity Electroblotting Module, VS10BI-HI (4)		
VS10DCI	omniPAGE Mini Tube Unit (2)	VS10BI-HI	High Intensity omniPAGE Blot Mini insert - includes 2 cassettes and 8 fibre pads (4)
VS10BI	OmniBlot Mini Insert - including 4 cassettes, 16 foam pads (3)		